

Instructions for Use

Thermo Scientific Large Capacity Adapters

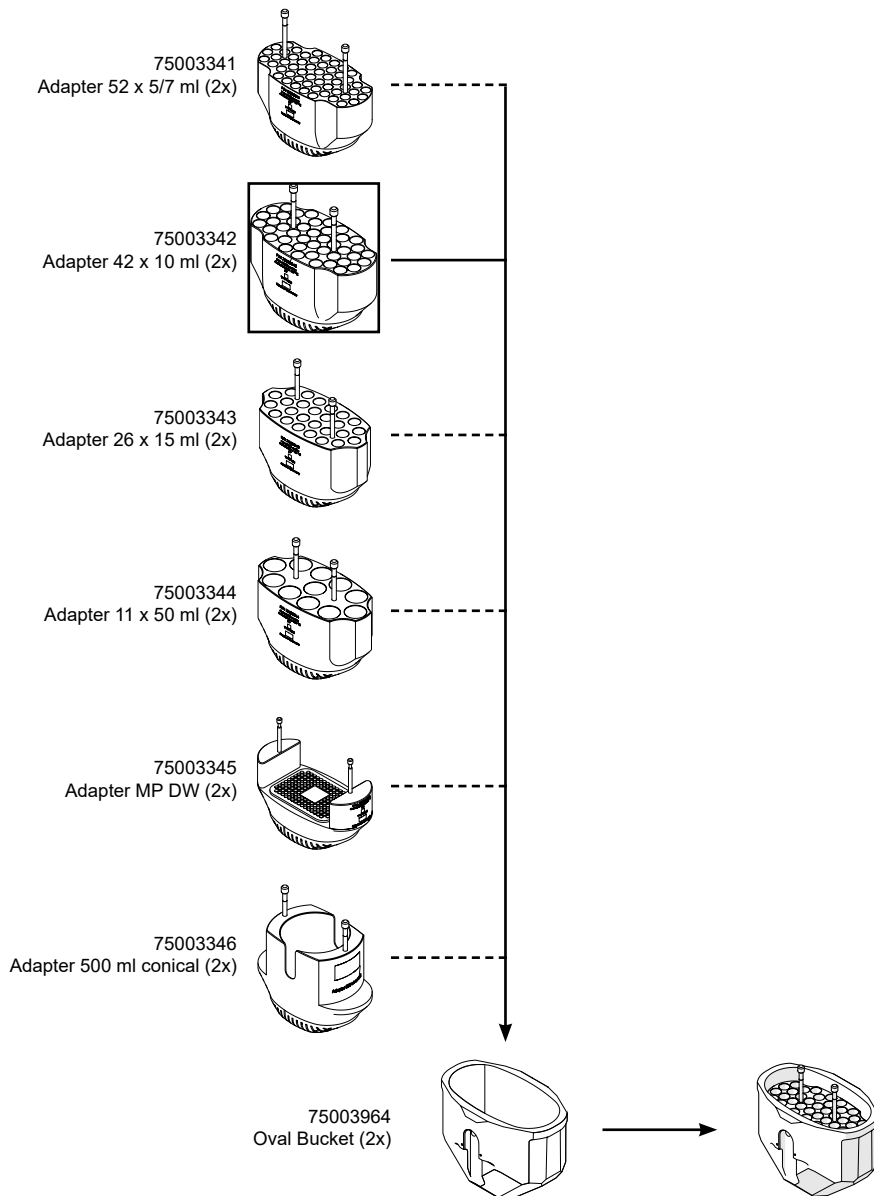

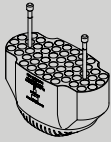

75003341

Adapter 52 x 5/7 ml (2x)

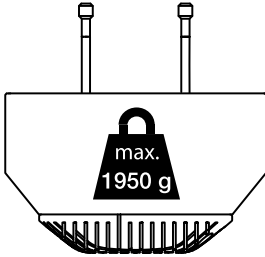

max.
5400 x g

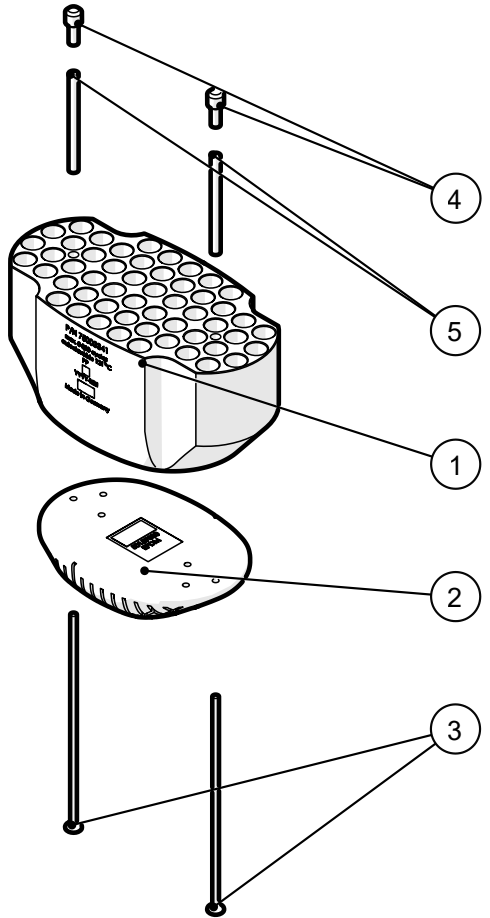
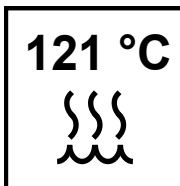
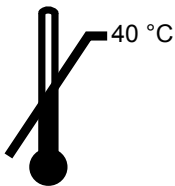

ID	Description	Material	Qty
1	Adapter 52 x 5/7 ml	PP	1
2	Cushion	EPDM	1
3	Flathead Screw	Stainless Steel	2
4	Screw Handle	Stainless Steel	2
5	Spacer Sleeve	Stainless Steel	2

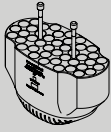

75003342

Adapter 42 x 10 ml (2x)

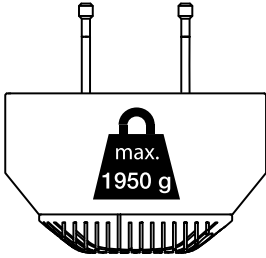

max.
5400 x g

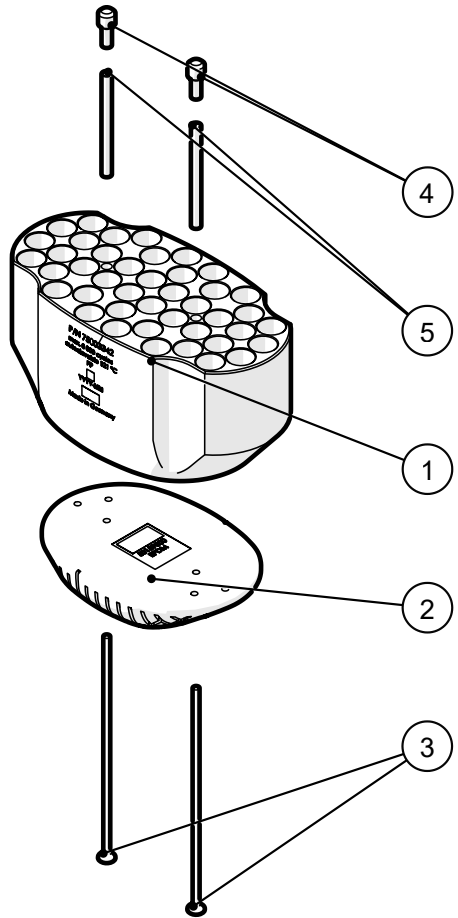
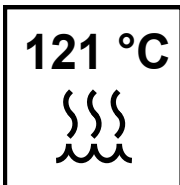
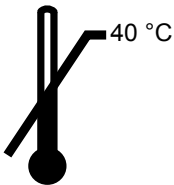

ID	Description	Material	Qty
1	Adapter 42 x 10 ml	PP	1
2	Cushion	EPDM	1
3	Flathead Screw	Stainless Steel	2
4	Screw Handle	Stainless Steel	2
5	Spacer Sleeve	Stainless Steel	2

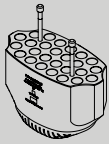

75003343

Adapter 26 x 15 ml (2x)

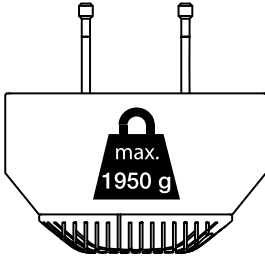

max.
5400 x g

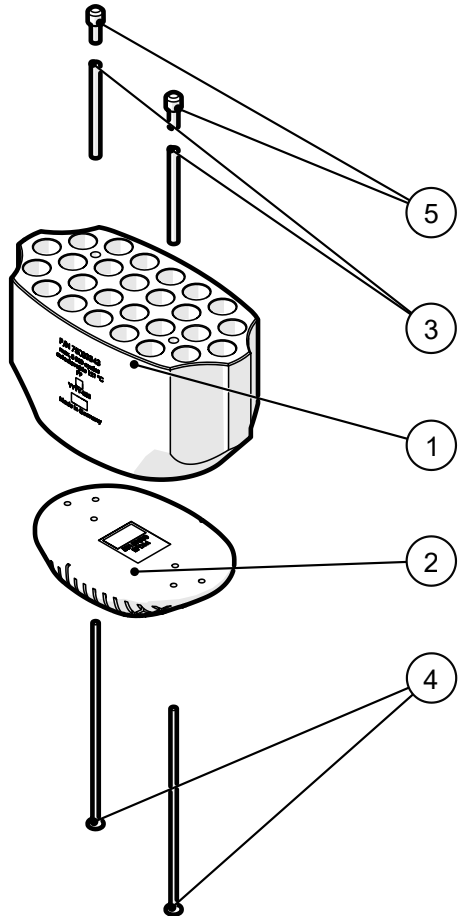
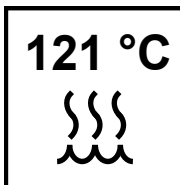
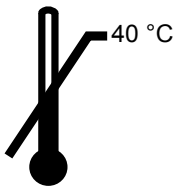

ID	Description	Material	Qty
1	Adapter 26 x 15 ml	PP	1
2	Cushion	EPDM	1
3	Flathead Screw	Stainless Steel	2
4	Screw Handle	Stainless Steel	2
5	Spacer Sleeve	Stainless Steel	2

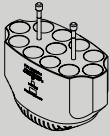

75003344

Adapter 11 x 50 ml (2x)

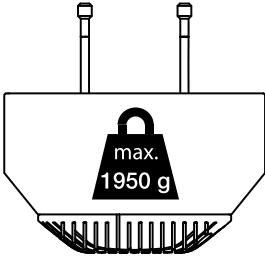

max.
5400 x g

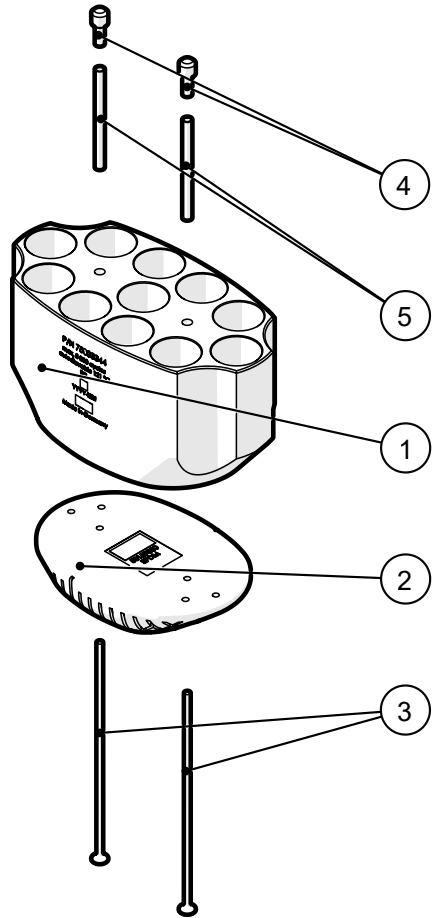
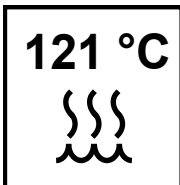
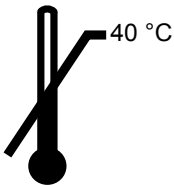

ID	Description	Material	Qty
1	Adapter 11 x 50 ml	PP	1
2	Cushion	EPDM	1
3	Flathead Screw	Stainless Steel	2
4	Screw Handle	Stainless Steel	2
5	Spacer Sleeve	Stainless Steel	2

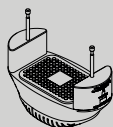

75003345

Adapter MP DW (2x)

5x MP / 1x DW

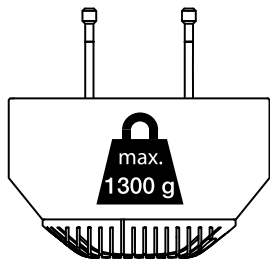

max.
5400 x g

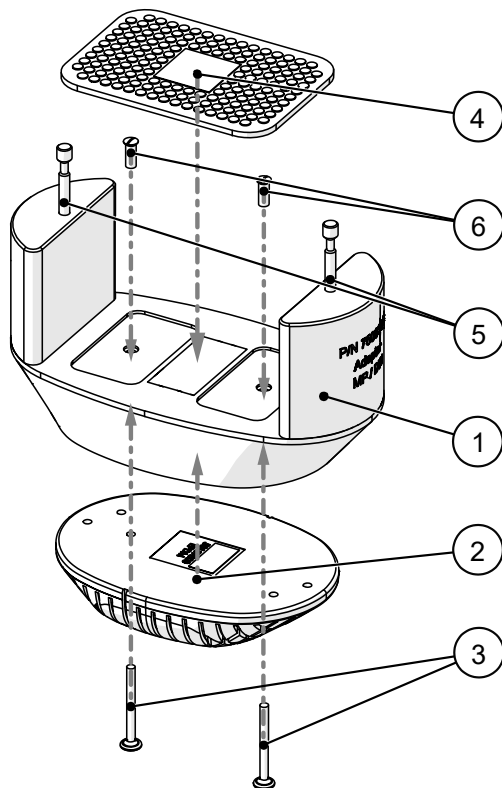
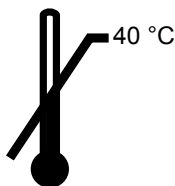
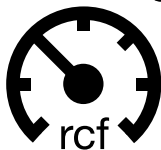

ID	Description	Material	Qty
1	Adapter MP DW	PP	1
2	Cushion	EPDM	1
3	Flathead Screw	Stainless Steel	2
4	Rubber Plate Carrier	EPDM	1
5	Screw Bolt	Stainless Steel	2
6	Sleeve Nut	Nickel	2

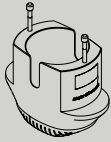

75003346

Adapter 500 ml conical (2x)

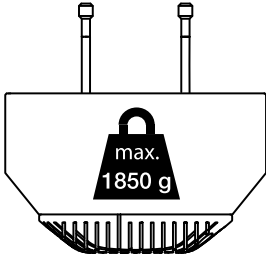

max.
5400 x g

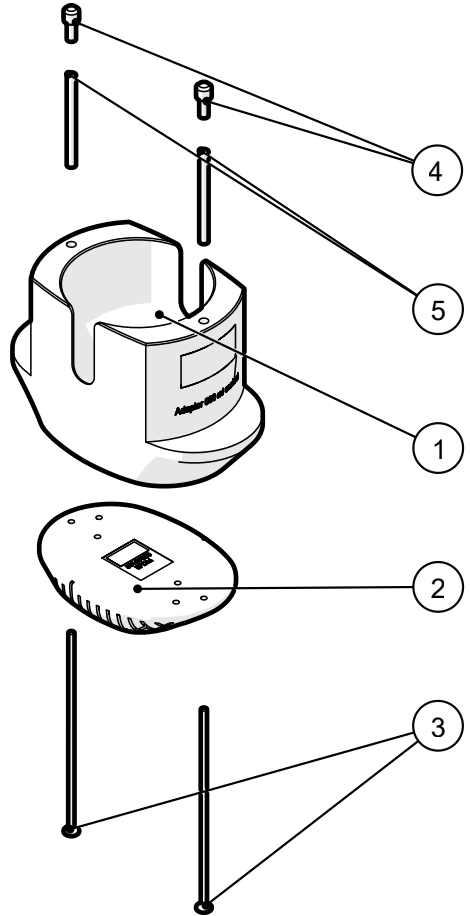
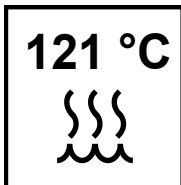
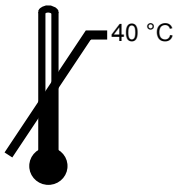

ID	Description	Material	Qty
1	Adapter 500 ml conical	PP	1
2	Cushion	EPDM	1
3	Flathead Screw	Stainless Steel	2
4	Screw Handle	Stainless Steel	2
5	Spacer Sleeve	Stainless Steel	2

EN: For instructions and further information, refer to the instruction manual delivered with the centrifuge. Please check www.thermofisher.com for updated lists and related documents.

DE: Für Instruktionen und weitere Informationen, beachten Sie die Gebrauchsanweisung, die mit der Zentrifuge geliefert wird. Bitte besuchen Sie www.thermofisher.com für aktualisierte Listen und zugehörige Dokumente.

FR: Pour de plus amples instructions et informations, veuillez consulter le manuel d'utilisation livré avec la centrifugeuse. Veuillez consulter le site www.thermofisher.com pour les listes mises à jour et les documents connexes.

IT: Per ulteriori informazioni e istruzioni, consultare il manuale d'uso fornito insieme alla centrifuga. Si prega di consultare il sito www.thermofisher.com per gli elenchi aggiornati e la relativa documentazione.

PT: Consulte o manual de instruções fornecido com a centrífuga para obter instruções e outras informações. Consulte www.thermofisher.com para obter listas atualizadas e documentos relacionados.

ES: Para las instrucciones e informaciones más detalladas, consulte el manual de uso, suministrado con la centrifuga. Por favor visite www.thermofisher.com para ver las listas actualizadas y los documentos relacionados.

NL: Belangrijke instructies en verdere informatie vindt u in de bedieningshandleiding die met de centrifuge werd meegeleverd. Kijk op www.thermofisher.com voor bijgewerkte lijsten en bijbehorende documenten.

DA: Se brugsanvisningen, der leveres sammen med centrifugen, for instruktioner og yderligere oplysninger. Se www.thermofisher.com for opdaterede lister og tilhørende dokumenter.

SV: Instruktioner och ytterligare information finner ni i bruksanvisningen som levererades med centrifugen. På www.thermofisher.com finns aktuella listor och tillhörande dokument.

BG: За инструкции и допълнителна информация вземете под внимание инструкцията за употреба, доставена с центрофугата. Моля посетете www.thermofisher.com за актуализирани списъци и съответни документи.

HR: Za upute i dodatne informacije, pogledajte priručnik s uputama isporučen uz centrifugu. Za ažurirani popis i s njim povezane dokumente provjerite www.thermofisher.com.

CS: Řiďte se pokyny a dalšími informacemi uvedenými v návodu k použití dodaném s centrifugou. Aktualizované seznamy a příslušné dokumenty najdete na www.thermofisher.com.

ET: Juhiste ja lisateabe saamiseks lugege tsentrifugiga kaasasolevat kasutusjuhendit. Ajakohastatud loendite ja nendega seotud dokumentide kohta minge aadressile www.thermofisher.com.

FI: Ohjeita ja tarkempia tietoja saat ohjekirjasta, joka toimitetaan sentrifugin mukana. Tarkista päivitetty listat ja asiaanliittyvät dokumentit osoitteesta www.thermofisher.com.

EL: Για οδηγίες και περισσότερες πληροφορίες, συμβουλευτείτε το εγχειρίδιο οδηγιών που παραδόθηκε με τη συσκευή φυγοκέντρωσής σας. Στην ιστοσελίδα www.thermofisher.com θα βρείτε ενημερωμένες λίστες και σχετικά έγγραφα.

HU: További információkat és útmutatást a centrifugával szállított Kezelési útmutatóban talál. Az aktualizált listákért és a többi dokumentációért keresse fel a <http://www.thermofisher.com> weboldalt.

LV: Norādījumus un papildu informāciju skatiet iekļautajā centrifūgas lietošanas pamācības komplektācijā. Lūdzu, apmeklējiet www.thermofisher.com, lai atjauninātu sarakstus un saistītos dokumentus.

LT: Instrukcijų ir daugiau informacijos žr. su centrifuga pateiktame instrukcijų vadove. Atnaujintų sąrašų ir susijusios informacijos ieškokite www.thermofisher.com.

PL: Aby uzyskać wskazówki i dalsze informacje, należy zapoznać się z instrukcją obsługi dostarczoną wraz z wirówką. Aktualizacje list i powiązane z nimi dokumenty można znaleźć na stronie www.thermofisher.com.

RO: Pentru instrucțiuni și informații suplimentare, consultați manualul de instrucțiuni furnizat cu centrifuga. Consultați site-ul web www.thermofisher.com pentru liste actualizate și documente conexe.

SK: Pokyny a ďalšie informácie nájdete v návode na použitie, ktorý bol dodaný spolu s odstredivkou. Aktualizované zoznamy a súvisiace dokumenty si pozrite na www.thermofisher.com.

SL: Za nadaljnja navodila in informacije upoštevajte navodila za uporabo, ki so priložena centrifugi. Prosimo, preverite na www.thermofisher.com za posodobljanje seznamov in dokumentov.

NO: For brukerveiledning og ytterligere informasjon, les bruksanvisningene som fulgte med sentrifugen. Besøk www.thermofisher.com for å finne oppdaterte lister og relevante dokumenter.

TR: Talimatlar ve ayrıntılı bilgiler için santrifüjle birlikte verilen kullanma kılavuzuna bakınız. Güncel listeler ve ilgili dokümanlar için lütfen www.thermofisher.com adresini ziyaret ediniz.

JP: 使用方法や詳細については、遠心機に付属の取扱説明書をご参照ください。最新リストおよび関連文書については、www.thermofisher.comをご覧ください。

ZH: 有关说明和更多信息，请参见离心机随附的说明手册。有关更新列表和相关文档，请查看 www.thermofisher.com。

RU: Инструкции и прочая информация приведены в руководстве по эксплуатации, прилагаемом к центрифуге. Для получения обновленных списков и соответствующих документов пройдите по ссылке: www.thermofisher.com.

KO: 자세한 내용을 보려면 원심 분리기와 함께 제공되는 사용 설명서를 참조하십시오.

최신 목록 및 관련 문서는 www.thermofisher.com에서 찾아볼 수 있습니다.

SR: Uputstva i dodatne informacije potražite u priručniku za korišćenje koji je isporučen uz centrifugu. Proverite takođe na veb lokaciji www.thermofisher.com da li postoje ažurirane liste i odgovarajući dokumenti.



Thermo Electron LED GmbH
Zweigniederlassung Osterode
Am Kalkberg, 37520 Osterode am Harz
Germany

Australia +61 39757 4300
Austria +43 1 801 40 0
Belgium +32 9 272 54 82
China +800 810 5118, +400 650 5118
France +33 2 2803 2180
Germany national toll free 0800 1 536 376
Germany international +49 6184 90 6000
India toll free +1800 22 8374
India +91 22 6716 2200
Italy +39 02 95059 552
Japan +81 3 5826 1616
Korea +82 2 2023 0600
Netherlands +31 76 579 55 55
New Zealand +64 9 980 6700
Nordic/Baltic/CIS countries +358 10 329 2200
Russia +7 812 703 42 15, +7 495 739 76 41
Singapore +82 2 3420 8700
Spain/Portugal +34 93 223 09 18
Switzerland +41 44 454 12 12
UK/Ireland +44 870 609 9203
USA/Canada +1 866 984 3766
Other Asian Countries +852 3107 7600
Countries not listed +49 6184 90 6000

© 2020–2022 Thermo Fisher Scientific Inc. All rights reserved.

All trademarks are the property of Thermo Fisher Scientific Inc. and its subsidiaries unless otherwise indicated.