

CATALOG NUMBER	1205-4000	
MATERIAL	PP	
NOM. CAP. (mL)	4000	
SIZE (NOM VOL mL)	4000	
NOM. BRIM CAP (mL)	5600	
NOM. WEIGHT (GM)	239	
	INCH	(MM)
A (LIP DIA.)	7.68±.05	195.0
B (DIM.)	8.44±.05	214.4
C (BOTTOM DIA.)	6.30±.05	160.0
D (INSIDE DIA.)	7.30±.05	185.4
H (HEIGHT)	9.84±.05	250.0
W. T. (NOM. WALL THK)	.065	1.65

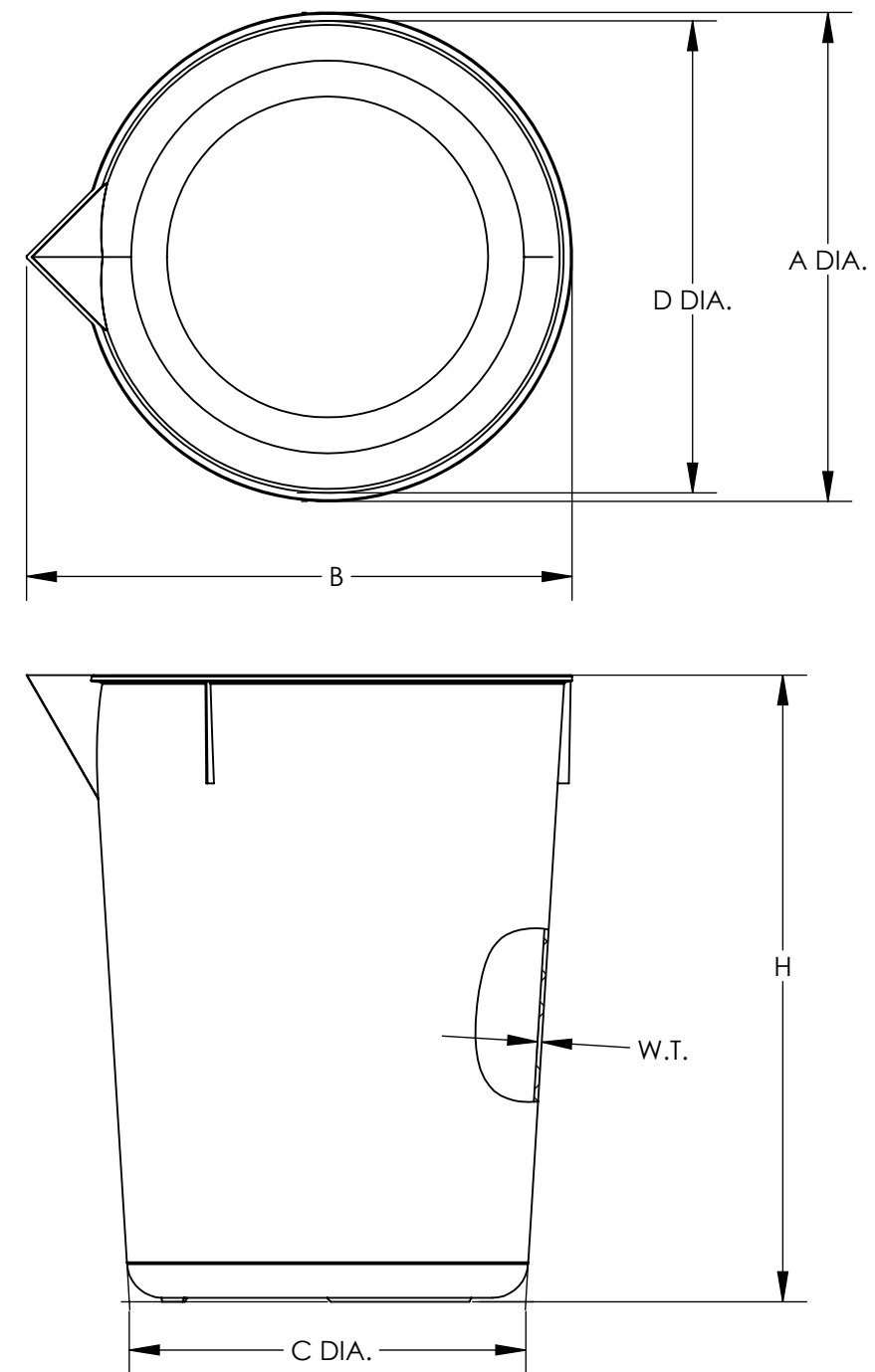

SPECS ON BACK

NOT TO SCALE

1. ALL DIMENSIONS ARE NOMINAL AND IN INCHES AND MILLIMETERS UNLESS OTHERWISE NOTED.
2. THIS IS NOT A PRODUCTION DRAWING, BUT IS FOR INFORMATIONAL PURPOSES ONLY, AND IS SUBJECT TO CHANGE WITHOUT NOTICE.

CONFIDENTIAL

THIS PRODUCT SPECIFICATION SHEET CONTAINS CONFIDENTIAL AND/OR PROPRIETARY INFORMATION AND IS TO BE USED ONLY FOR THE EXPRESSED PURPOSES AGREED UPON BY AN AUTHORIZED OFFICER OF THERMO FISHER SCIENTIFIC.

ThermoFisher
SCIENTIFIC

Thermo Fisher Scientific
75 Panorama Creek Drive
Rochester, NY 14625-2385, USA

MADE	EJL	APP'D	MJR	PSS 1205-4000	REV. 0518
CK'D	MJR	6/19/18			
DESCRIPTION: NALGENE ECONOMY BEAKER PPCO 4000ML					