

CATALOG NUMBER	1205-0100	
MATERIAL	PP	
NOM. CAP. (mL)	100	
SIZE (NOM VOL mL)	100	
NOM. BRIM CAP (mL)	155	
NOM. WEIGHT (GM)	13	
	INCH	(MM)
A (LIP DIA.)	2.50±.05	64.5
B (DIM.)	2.77±.05	70.4
C (BOTTOM DIA.)	2.03±.05	51.6
D (INSIDE DIA.)	2.27±.05	57.7
H (HEIGHT)	2.89±.05	73.4
W. T. (NOM. WALL THK)	.040	1.02

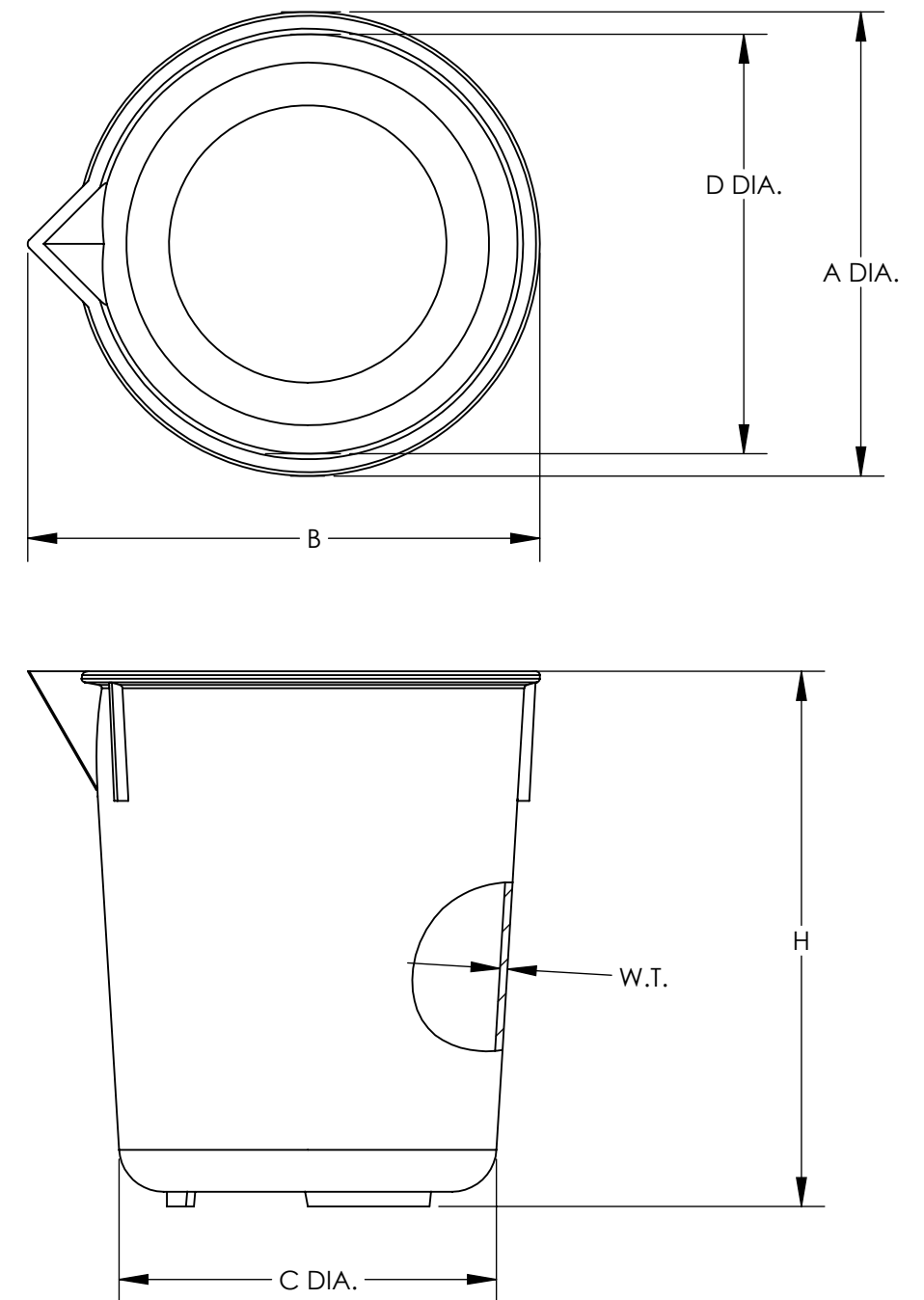

SPECS ON BACK

NOT TO SCALE

CONFIDENTIAL

THIS PRODUCT SPECIFICATION SHEET CONTAINS CONFIDENTIAL AND/OR PROPRIETARY INFORMATION AND IS TO BE USED ONLY FOR THE EXPRESSED PURPOSES AGREED UPON BY AN AUTHORIZED OFFICER OF THERMO FISHER SCIENTIFIC.

ThermoFisher
SCIENTIFIC

Thermo Fisher Scientific
75 Panorama Creek Drive
Rochester, NY 14625-2385, USA

MADE	EJL	APP'D	MJR	PSS 1205-0100	REV. 0518
CK'D	MJR	6/19/18			
DESCRIPTION: NALGENE ECONOMY BEAKER PPCO 100ML					

1. ALL DIMENSIONS ARE NOMINAL AND IN INCHES AND MILLIMETERS UNLESS OTHERWISE NOTED.
2. THIS IS NOT A PRODUCTION DRAWING, BUT IS FOR INFORMATIONAL PURPOSES ONLY, AND IS SUBJECT TO CHANGE WITHOUT NOTICE.